

Products > Aperture Wafers > A18.00

Aperture Wafers - A18.00

Specifications

Model	A18.00
Inside Diameter	.0030/.00315"
Outside Diameter	.144/.122"
Thickness	.024/.026"
Radius	.025/.035"
ID Length	.0018/.0022"



Description

Aperture Wafers are precision controlled orifices where the ID Length is controlled very tightly.

Typical Applications

- Hematology Instrumentation
- Ink Jet Printing
- Flow Control

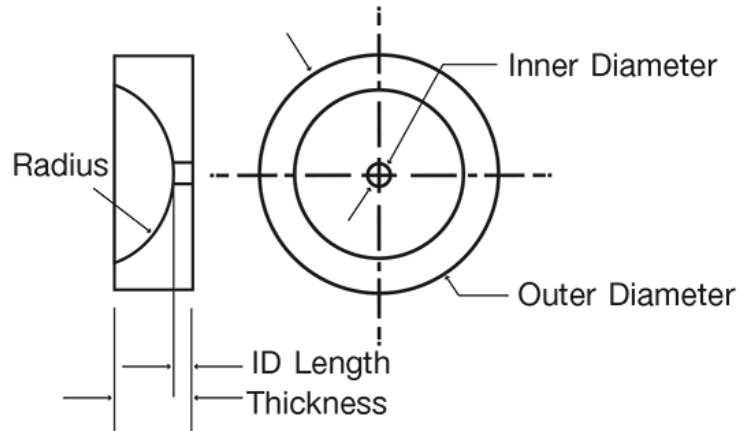

NOT SEEING EXACTLY WHAT YOU NEED?

We specialize in creating a wide range of custom optical components and custom mechanical components including a variety of shapes - from internal holes and tapers to outer flanges, angles and surface finishes. Contact us and we will consult with you to create a custom component that meets all of your specifications.